









## High-Tech Commercial Pool Disinfection with Powerful Performance







The CCH® Elite feeder is a high capacity erosion (HCE) feeder that is compact and lightweight with a modular design. The feeder uses CCH® 1" calcium hypochlorite tablets that work in conjunction to produce a fresh concentrated liquid chlorine solution for clean and sanitized water. This innovative feeder system is easy to maintain and service with a flexible design that allows for easy integration for small to large commercial pools.

Switch to the CCH® Elite Feeder System, delivering clear and sparkling water time and time again!

### Powerful Feeder Performance

-  Provides consistent chlorine delivery
-  Feeder designed to minimize maintenance requirements
-  2 in 1 dust reduction funnel for loading tablets with capacity extension
-  Rotomolded components hold up to the strongest elements
-  Feeder design allows for easy access to internal components
-  Features high capacity erosion technology with the benefits of a venturi and booster pump

### Tablet Efficiencies

-  Won't overstabilize pool
-  More concentrated than liquid bleach
-  Dry, easy to handle formulation
-  Will not cause reduction of ORP
-  Highly concentrated to reduce shipping and handling costs
-  Longer shelf life when compared to liquid bleach

**A 3-in-1 product that chlorinates consistently, increases calcium to protect plaster and balances alkalinity to stabilize pH!**





### Feeder Specifications

Width	25.3"	642.62mm
Depth	29.8"	756.92mm
Height	40.9"	1038.89mm
Water Inlet Size	1/2" MNPT	12.7mm MNPT
Solution Outlet Size	1/2" MNPT	12.7mm MNPT
Operating Weight	220lbs	99.7kg
Shipping Weight	60lbs	27.7kg
Dry Chemical Capacity	90 – 135lbs*	40.82 – 61.23kg*
Feed Rate Range – Pool	5 – 173 lbs AvCL/day	2.3 – 78.47 kg AvCL/day
Feed Rate Range – Spa	5 – 178 lbs AvCL/day	2.3 – 80.73 kg AvCL/day
Electrical	115VAC	
Operating Temperature	40° – 120° F	4.4° – 35°C

\*Higher capacity with inverted bucket placed into top funnel

### Tablet Specifications

Active Ingredient	Calcium Hypochlorite	
Available Chlorine	68%	
Weight	20g	
Chemical Form	Tablet	
Diameter	1"	25.4mm
Color	White	
Container	Pail	
Container Weight	45lbs	20.4kg

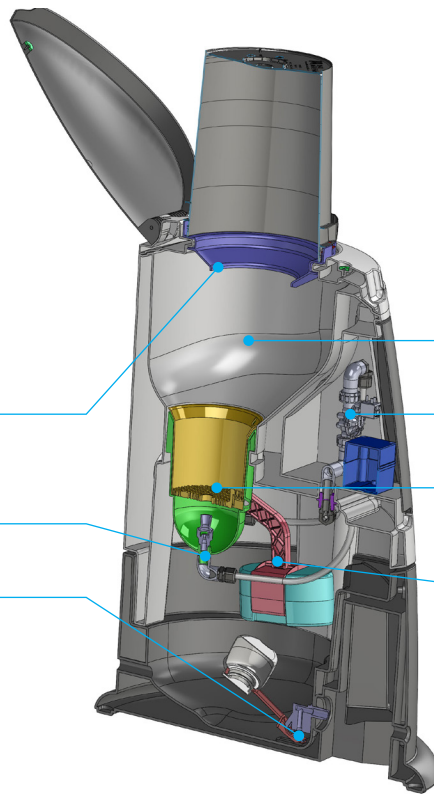

Hopper

#### Enhanced hopper attachment

allows for added chemical capacity and reduction in dust during chemical loading

Dual solenoids minimize solid build up

Tablet grid

Removable for easy maintenance

#### High capacity erosion nozzle

#### Durable discharge valve

Emergency shut-off valve to prevent spills

**For more information visit [www.cchpoolcare.com](http://www.cchpoolcare.com) or call us at 1-800-478-5727**